

## SERIES DMTFH Handheld

**Series DMTFH Handheld Transit Time Ultrasonic Flow Meter** is carefully designed so that it is very compact and easy to use. A user can use hand to hold as well as to operate the flow meter main unit. The user-interface is self-explanatory and very easy to follow. Besides, the unique clamp-on fixture design makes the installation very simple and no special skills or tools required. Due to the non-intrusive nature of the clamp-on technique, there is no pressure drop, no moving parts, no leaks and no contamination.

### Features:

- ◆ carefully designed so that is very compact and ease to use.
- ◆ Advanced MultiPulse™ Technology
- ◆ convenient for mobile measurement, flow rate calibration, data comparing, meters running status checking
- ◆ Wide liquid applications
- ◆ Provides Data Logger functions. The capacity is based on how much the users selected, and maximum can reach to 8GB.



### Applications:

- ◆ Water, including hot water, chilled water, city water, sea water, etc.
- ◆ Sewage and drainage water with small particle quantity.
- ◆ Oil, including crude oil, lubricating oil, diesel oil, fuel oil, etc.
- ◆ Chemicals, including alcohol, acids, etc.
- ◆ Solvents
- ◆ Beverage and food processors
- ◆ HVAC hot and cool water, water /glycol solutions.
- ◆ Water and waste treatment
- ◆ Power plants (nuclear power plants, thermal & hydropower plants), heat energy boiler feed water.
- ◆ Energy consumption supervision and water conservation management
- ◆ Metallurgy and miming applications (e.g., acid recovery)
- ◆ Marine operation and maintenance
- ◆ Pulp and paper industries
- ◆ Pipeline leak detection, inspection, tracking and collection
- ◆ Energy measurement and balancing
- ◆ Network monitoring

## Principle of Measurement

DMTF transit time flow meter utilizes two transducers that function as both ultrasonic transmitters and receivers. The transducers are clamped on the outside of a closed pipe at a specific distance from each other. The transducers can be mounted in V-method in which case the ultra sound transverses the pipe twice, or W-method in which case the ultra sound transverses the pipe four times, or in Z-method in which case the transducers are mounted on opposite sides of the pipe and the ultra sound transverses the pipe only once. The selection of mounting method depends on pipe and liquid characteristics. When the flow meter works, the two transducers transmits and receives ultrasonic signals amplified by multi beam which travels firstly downstream and then upstream (Figure 1). Because ultra sound travels faster downstream than upstream, there will be a difference of time of flight( $\Delta t$ ). When the flow is still, the time difference( $\Delta t$ ) is zero. Therefore, as long as we know the time of flight both downstream and upstream, we can work out the time difference, and then the flow velocity (V) and flow volume (Q) via the following formula.

$$V = K * D * \Delta t$$

V: Liquid velocity

K: Constant

D: Distance between the two transducers

$\Delta t$  : Difference in time of flight

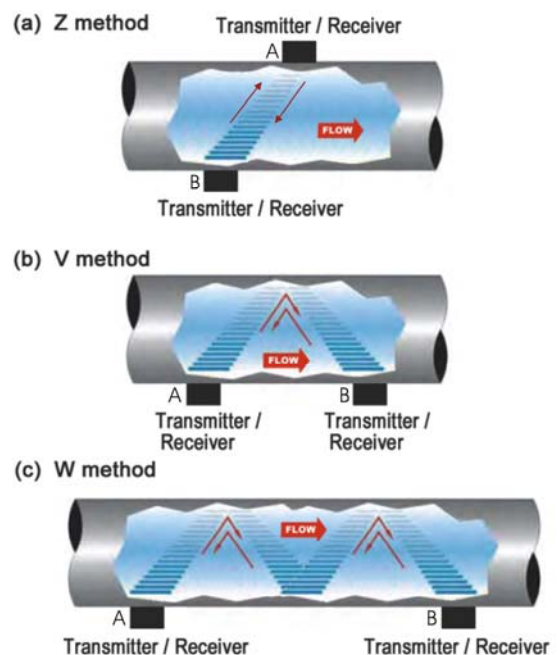

Figure 1

## Selection Table of DMTFH Handheld Ultrasonic Flow Meter

Model	DMTFH	- X	X	-	X	/ * (Transducers)
Handheld Series						
<b>Output Selection 1</b>						
N—N/A						
1—OCT Pulse (Flow Rate or Totalizer Output)						
2—RS232						
3—Data Logger & Software						
<b>Output Selection 2</b>						
Same as Output Selection 1						
<b>Power Supply (charger connector type)</b>						
A—115VAC( Two Round Terminals )						
B—230 VAC( Two Round Terminals )						
C—100VAC( Two Rectangular Terminals )						
D—230 VAC( Two Rectangular Terminals )						
Model	DH	- X	X	X		
<b>Transducer Type</b>						
S—Small(12-50mm)						
M—Middle(40-1000mm)						
L—Large(1000-4570mm)						
Transducers Temperature						
N—-40~121°C						
H—-40~250°C (Exclusive S, L transducer type)						
<b>Cable Length</b>						
S1 -- 4m Flexible cable						
L1 -- 8m Flexible cable						
S2 -- 5m non-Flexible cable						
L2 -- 10m non-Flexible cable						

**Parts Number Construction example:**

DMTFH-1N-A/DH-MNS1

**Description:** DMTFH Handheld ultrasonic flow meter, OCT pulse output, Non-multiple output selections, with 115VAC charger connector type; welded directly for the pipe of transducers, standard M type transducer, standard temperature, 4 meters Flexible cable.

## Specifications

Transmitter	Power Supply	3 AAA Ni-H built-in batteries. When fully recharged it will last over 12 hours of operation. 100V-240VAC for the charger
	Velocity	0 ~ ±40 ft/s (0 ~ ±12m/s), bi-directional
	Display	4 line×16 English letters LCD back lit, can display total flow, flow rate, velocity and meter running status etc.
	Units Rate Totalized	User Configured (English and Metric); Rate and Velocity Display; (FWD, NET, REV or BATCH) gallons, ft <sup>3</sup> , barrels, lbs, liters, m <sup>3</sup> ,kg
	Output	4~20mA, Pulse, Relay, RS232C or RS485, options: up to 8 GB Data logger
	Accuracy	±1.0%-2.0% of reading at rates >0.5 m/s
		±0.005 m/s of reading at rates<0.5 m/s
	Sensitivity	Flow Rate: 0.001ft/s (0.0003m/s)
	Repeatability	0.2% of reading
	Security	Keypad lockout, access code enable
Dimensions and Weight	100*204*34 Weight: <0.6kg	
Transducer	Liquid Types Supported	Virtually most any liquid containing less than 2% total suspended solids (TSS) or aeration
	Suited Liquid Temperature	Std. Temp. Transducer: -40°C ~ 121°C High Temp. Transducer : -40°C ~ 250°C
	Dimensions and Weight	S: Size: 42*25*25; weight: <0.3kg M: Size: 60*43*43; weight: <0.6kg L: Size: 80*53*53; weight: <1.0kg
	Pipe Size	Std M transducer: 40-1000mm L transducer: 1000-4570mm S transducer: 12-50mm K-mode round: 12-50mm
Accessories	Portable Case	Size: 445*290*130; Weight: <3.5kg
	Couplant	Dow Corning 111 or 732 (112 for high temp.)
	Elastic Belts	2 bundles
	Battery Charger	1 pcs
	Data Logger & Software	Optional 512M to 8GB SD card Windows-based Software Utility, data logging, data report, data curve and analyze.

## Data Logger and Software Utility

Provides data logging, based SD card data memory structure, the memory capacity can be 512M, 1GB, 2 GB, 4 GB, 8 GB based SD card capacity. Normally, 1 GB can store 5 years data with 5 minutes logging interval.

Very easy to read data from SD card just plug out from Dynameters Data Logger, and run

Dynameters Data Logging and Analyze software, browse the SD card file.

Data report and Data Curve functions:

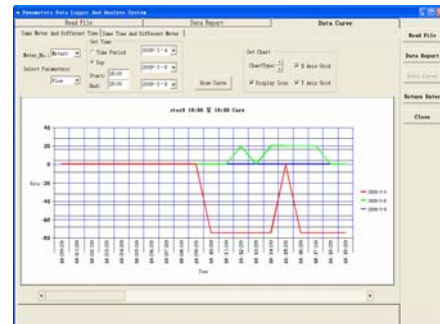
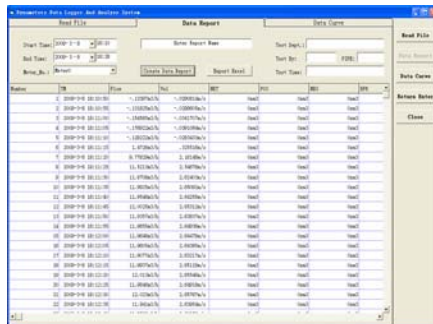

The Analyze Functions Include:

The curve based on the same Meter number but different time;

The curve based on the same time but different Meter number.

Logging Parameters: Flow Rate, Velocity



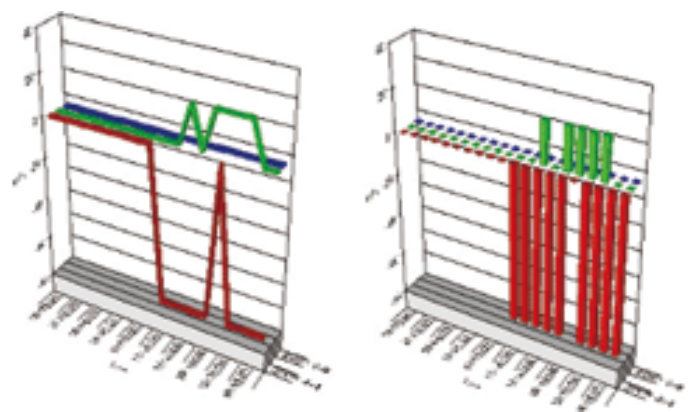

User can delete the uninterested parameters on the Excel Table and then print the data table.



We have two types of data logger, one for dedicated (including DMTFB, DMTFC, DMTFD, DMTFF, DMHF) and Portable (DMTFP) Series, the other for Handheld (DMTFH) Series.

Users can download the software from our website: [www.dynameters.com](http://www.dynameters.com)

**Parts & Dimensions**

<p><b>Handheld Transmitter</b></p> 		
<p><b>L Transducer</b></p> 	<p><b>S Transducer</b></p> 	
<p><b>Std. M Transducer</b></p> 	<p><b>K mode round</b></p> 	
<p><b>S-S Belts</b></p> 	<p><b>Couplant</b></p> 	<p><b>Elastic Belts</b></p> 

## Parts & Dimensions

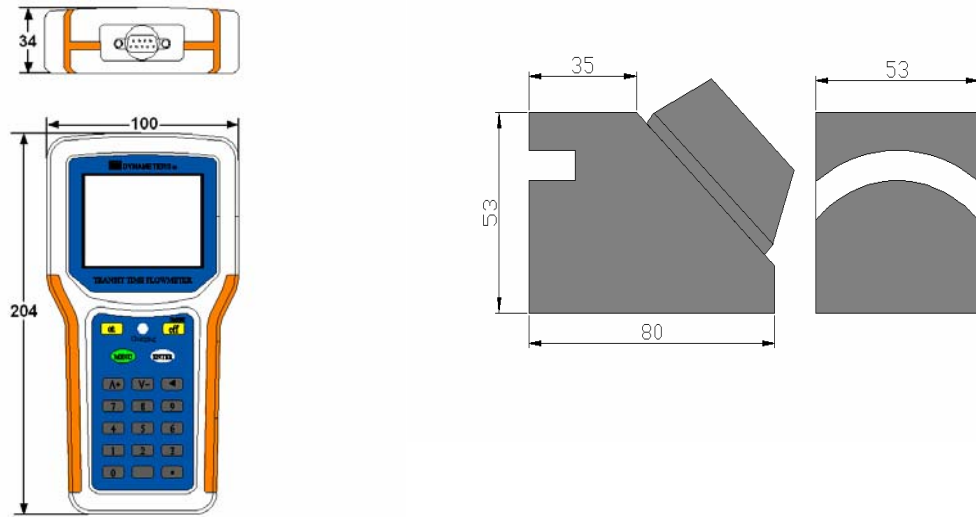

**Handheld Transmitter**

**L Transducer**

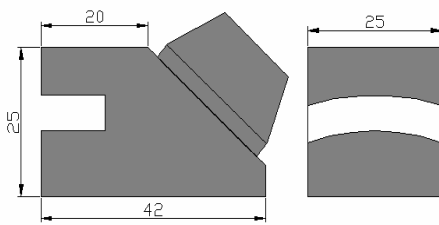

**S Transducer**

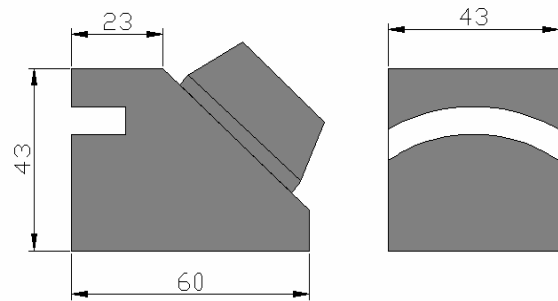

**Std. M Transducer**